



daisy
pool covers & rollers

Expert's Yearbook

Including 2022-23 prices*

AUSTRALIA'S FAVOURITE.

1300 55 18 11 • daisypoolcovers.com.au

Quality | Technology | Service    

*Recommended Retail Prices (inc. GST) Effective August 1 2022





CONTENTS

Cover Range	<i>For different jobs</i>	4
Solar Pool Covers		5
ThermoTech Foam Insulation Covers		6
WinterKleen Leaf Covers		6
Roller Range	<i>Rollers designed for every pool</i>	7
Roller Range - 5 Star 100mm		8
Roller Range - 5 Star 125mm		9
Roller Range - UTC		9
Electric Rollers - Daisy Power		10
Under Bench Rollers	<i>UBR</i>	11
Below Ground Pool Cover Box	<i>BGB</i>	12
Deck Mount Rollers	<i>DMR</i>	13
Commercial Range		14-18
Pricelists		19
250 Price Grid	<i>250B</i>	20
400 Price Grid	<i>400B</i>	20
350 Price Grid	<i>350i</i>	21
525 Price Grid	<i>525</i>	21
Thermal Foam Price Grid	<i>TT</i>	22
WinterKleen Price Grid	<i>WK</i>	23
WinterKap Price Grid	<i>WKAG</i>	24
Spa Foam	<i>Budget Spa Foam Cover</i>	24
How to Measure a WinterKleen		25
Roller Parts & Accessories		26
Roller Dimensions		28
Restock, Warranty, Freight, Installation Policy		29
How to Buy a Daisy		30-31
Pool Cover & Roller Order Form	<i>Just fill it in and Email</i>	32



Dear Daisy Customers,

We hope you enjoy the 2022/23 Expert's Year Book.

The Year Book provides you with a comprehensive overview of Daisy's range of pool covers and rollers. You'll also find current pricing structures around our full catalogue of products (as at the date of the publication).

Need to make an order? Too easy! Just head to page 30 where you will see our step-by-step process for ordering any one of our Daisy products.

So why is dealing with Daisy good for your business?

Daisy Pool Covers has been Australia's favourite pool cover and roller brand for over 39 years with the largest range of designs in the country. Our commitment to excellence and innovation provides pool owners with world-class products backed by outstanding levels of service. We know that's the confidence every customer wants!

Years of dedicated Daisy research and development has produced a range of pool covers and rollers that protect swimming pools all year round. Made from the highest quality materials, Daisy is both environmentally-responsible and cost effective, thanks to the saving of water, chemicals, time and, of course, heat retention.

To get all the information you need on Daisy's Australian-made range of pool covers and rollers, take a look at our 2022/23 Expert Year Book today.

On behalf of the Daisy team, I wish you all the best for the year ahead!

Yours sincerely,

Derek Prince



COVER RANGE

SOLAR POOL COVER RANGE

IDEAL FOR: Outdoor pools

Heat your water with the sun | Insulate and save heat loss | Stop evaporation

The most popular and easy to use is the Solar Pool Cover. These are bubble-style covers that let the sun heat your pool water by up to 8°C and retain heat by insulating your pool overnight.

The natural heating and insulating saves you energy while also stopping evaporation.

These covers are perfect to use on all pools, especially when the sun hits the cover, helping you gain maximum benefits.

Pool size price grid see page 20/21.



525B
Solar pool cover
Translucent Blue
10 Year pro rata warranty
525 micron
Most Popular
\$22.50m² inc. GST



525TG
Solar pool cover
Titanium Green
10 Year pro rata warranty
525 micron
\$22.50m² inc. GST



525TB
Solar pool cover
Titanium Blue
10 Year pro rata warranty
525 micron
\$22.50m² inc. GST



525TC
Titanium Cool
10 Year pro rata warranty
525 micron
Non Heating
\$22.50m² inc. GST



350i
Solar pool cover
Natural to the colour of your pool
5 Year pro rata warranty
350 micron
\$16.55m² inc. GST



400B
Solar pool cover
Translucent Blue
5 Year pro rata warranty
400 micron
Mid Range
\$18.20m² inc. GST

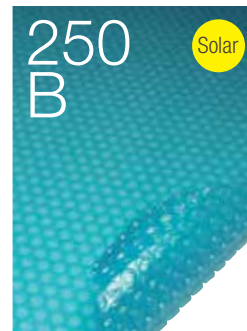

250B
Solar pool cover
Translucent Blue
3 Year pro rata warranty
250 micron
Budget
\$12.45m² inc. GST

REDUCE THE COST OF MAINTAINING A WARM SUSTAINABLE POOL.

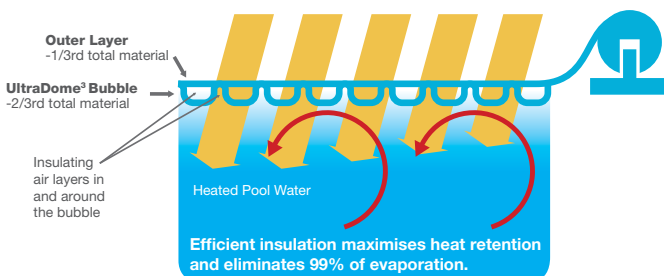

THE DAISY DIFFERENCE

The bubble is the same thickness throughout for greater strength and longer life

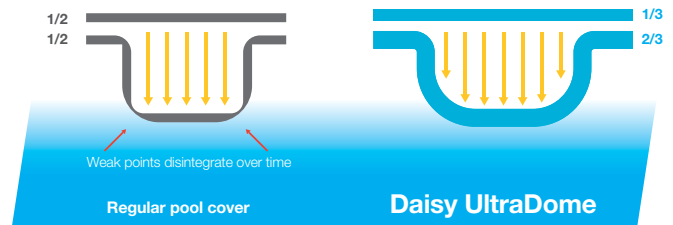

BENEFITS OF A DAISY SOLAR POOL COVER

- SAVE** on water,
up to 10,000L
per month.
Improves water
retention.
- SAVE** on
chemicals.
Reduce salt and
chemical use by
up to 50%.
- SAVE** money.
Higher quality.
Better design.
Lasts longer.
- STOP**
evaporation.
Reduces
evaporation
by 99%.
- SAVE** on
cleaning.
Helps keep out
dirt and leaves.
- SAVE** on time.
Rolls off and on in
30 seconds.
- SAVE** on
heat loss.
Reduced heating
costs and
heat loss.
- Warms** your
pool by up to
8°C for free.
- Australian
Made.**

THERMOTECH FOAM INSULATION COVER

IDEAL FOR: Pools that don't see the sun

High insulating cover | Great for indoor pools | Save on heating costs | 8 Year pro rata warranty | 4.5mm



The ThermoTech™ range is a high insulating cover ideal for both indoor and outdoor pools that primarily want to retain heat and reduce the energy costs of heating a pool with an external heat source, i.e. a heat pump, allowing you to save on energy costs and stop evaporation.

These covers are great in cooler climates where heat loading is greater, and are generally used indoor and overnight.

Pool size price grid see page 22.

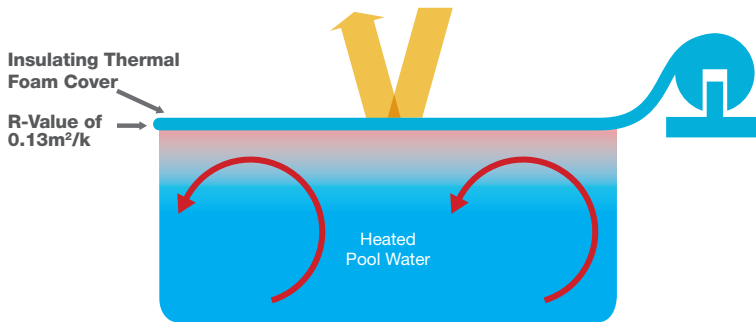

BENEFITS OF A THERMOTECH FOAM INSULATION COVER



SAVE on heat loss.
Reduced heating costs and heat loss.



SAVE on water, up to 10,000L per month.
Improves water retention.



SAVE on cleaning.
Helps keep out dirt and leaves.



SAVE money.
Higher quality. Better design. Lasts longer.



SAVE on chemicals.
Reduce salt and chemical use by up to 50%.



SAVE on time.
Rolls off and on in 30 seconds.



STOP evaporation.
Reduces evaporation by 99%.



Australian Made.

WINTERKLEEN LEAF COVER

IDEAL FOR: Pools with high debris

Mesh cover saves cleaning time | Great for windy or leafy areas | 8 Year pro rata warranty



WinterKleen pool covers are the ideal choice for pools that experience excess garden and leaf debris. These pool covers are installed over your pool so that any debris that falls onto the cover collects, blows off or is easily swept away. Water passes through but debris and dust stay out. WinterKleen covers work well in conjunction with a Solar Pool Cover to use during the off-season. Reducing evaporation and saving cleaning time, these covers are ideal for pools that have a high debris load.

Pool size price grid see page 23.

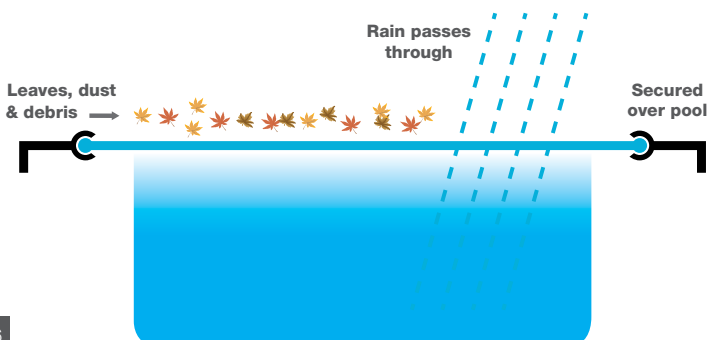

BENEFITS OF A WINTERKLEEN LEAF COVER



SAVE on cleaning.
Keep out dirt and leaves.



SAVE on time.



SAVE on evaporation.
Reduces evaporation by 80%.



Australian Made.



ROLLER RANGE



ROLLER RANGE - 5 STAR

100mm Roller Range for most backyard pools

All Rollers supplied with over cover and pool cover connection kit.
\$25 premium for non standard fixed length rollers to be manufactured.

DIY Roller Range: 2.5m universal tube assemblies with pre drilled & marked for standard tube sizes.
Easy install with stainless screws. DIY over covers for max tube length supplied.

Colour Options: For models that have colour options, default code for white option

Black Range: Add BK to code - A75BK(size) - STBK(size) - MKIIBK(size)

Grey Range: Add GY to code - A75GY(size) - STGY(size) - MKIIGY(size)

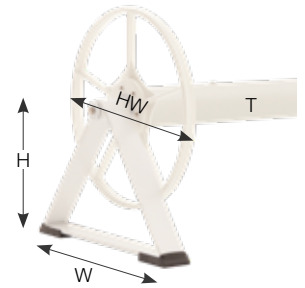

A75
White

Grey - A75GY

Black - A75BK

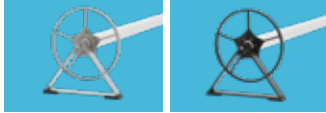

A75 Stationary

5 Star quality-Small to medium pools
10 Year pro rata warranty

H 260mm W 420mm T 75mm HW 375mm

Code	Tube (m)	Pool size	Price
A7534	3.4	3.1 x 12.0	\$575.00
A7537	3.7	3.4 x 12.0	
A7540	4.0	3.7 x 12.0	
A7543	4.3	4.0 x 12.0	
A7546	4.6	4.3 x 12.0	\$540.00
A75DIYS	Universal to 4.6		
A10049	4.9	4.6 x 12.0	\$686.00
A10052	5.2	4.9 x 12.0	
A10055	5.5	5.2 x 12.0	
A10058	5.8	5.5 x 12.0	
A100DIYL	Universal to 5.8		\$625.00



SQ

SQ Squat

5 Star quality-Small to large pools
10 Year pro rata warranty

H 195mm W 430mm T 100mm HW 375mm

Code	Tube (m)	Pool size	Price
SQ40	4.0	3.7 x 12.0	\$627.00
SQ43	4.3	4.0 x 12.0	
SQ46	4.6	4.3 x 12.0	
SQDIYS	Universal to 4.6		
SQ49	4.9	4.6 x 12.0	\$714.00
SQ52	5.2	4.9 x 12.0	
SQ55	5.5	5.2 x 10.0	
SQ58	5.8	5.5 x 10.0	
SQDIYL	Universal to 5.8		\$649.00



ST
White

Grey - STGY

Black - STBK

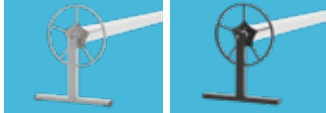

ST Stationary

5 Star quality-Medium to large pools
10 Year pro rata warranty

H 395mm W 485mm T 100mm HW 375mm

Code	Tube (m)	Pool size	Price
ST40	4.0	3.7 x 18.0	\$688.00
ST43	4.3	4.0 x 18.0	
ST46	4.6	4.3 x 18.0	
STDIYS	Universal to 4.6		
ST49	4.9	4.6 x 18.0	\$776.00
ST52	5.2	4.9 x 18.0	
ST55	5.5	5.2 x 14.0	
ST58	5.8	5.5 x 14.0	
ST61	6.1	5.8 x 14.0	\$706.00
ST64	6.4	6.1 x 14.0	
STDIYL	Universal to 6.4		



MKII
White

Grey - MKIIGY

Black - MKIIBK

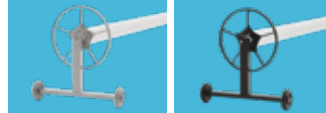

MKII Directional Mobile

5 Star quality-Medium to large pools
10 Year pro rata warranty

H 395mm W 570mm T 100mm HW 375mm

Code	Tube (m)	Pool size	Price
MKII40	4.0	3.7 x 18.0	\$711.00
MKII43	4.3	4.0 x 18.0	
MKII46	4.6	4.3 x 18.0	
MKIIDIYS	Universal to 4.6		
MKII49	4.9	4.6 x 18.0	\$806.00
MKII52	5.2	4.9 x 18.0	
MKII55	5.5	5.2 x 14.0	
MKII 58	5.8	5.5 x 14.0	
MKII61	6.1	5.8 x 14.0	\$732.00
MKII 64	6.4	6.1 x 14.0	
MKIIDIYL	Universal to 6.4		



LP

LP Low Profile - Fully Mobile

5 Star quality-Medium to large pools
10 Year pro rata warranty

H 240mm W 485mm T 100mm HW 375mm

Code	Tube (m)	Pool size	Price
LP40	4.0	3.7 x 13.0	\$784.00
LP43	4.3	4.0 x 13.0	
LP46	4.6	4.3 x 13.0	
LPDIYS	Universal to 4.6		
LP49	4.9	4.6 x 13.0	\$870.00
LP52	5.2	4.9 x 13.0	
LP55	5.5	5.2 x 10.0	
LP58	5.8	5.5 x 10.0	
LP61	6.1	5.8 x 10.0	\$795.00
LP64	6.4	6.1 x 10.0	
LPDIYL	Universal to 6.4		



FM

FM Fully Mobile

5 Star quality-Medium to large pools
10 Year pro rata warranty

H 395mm W 570mm T 100mm HW 375mm

Code	Tube (m)	Pool size	Price
FM40	4.0	3.7 x 18.0	\$803.00
FM43	4.3	4.0 x 18.0	
FM46	4.6	4.3 x 18.0	
FMDIYS	Universal to 4.6		
FM49	4.9	4.6 x 18.0	\$890.00
FM52	5.2	4.9 x 18.0	
FM55	5.5	5.2 x 14.0	
FM58	5.8	5.5 x 14.0	
FM61	6.1	5.8 x 14.0	\$816.00
FM64	6.4	6.1 x 14.0	
FMDIYL	Universal to 6.4		



AGA

AGA Above Ground Adjustable

5 Star quality-Medium pools
10 Year pro rata warranty

H 930mm to 1530mm W 1060mm T 100mm HW 375mm

Code	Tube (m)	Pool size	Price
AGA40	4.0	3.7 x 18.0	\$1,054.00
AGA43	4.3	4.0 x 18.0	
AGA46	4.6	4.3 x 18.0	
AGADIYS	Universal to 4.6		
AGA49	4.9	4.6 x 18.0	\$1,133.00
AGA52	5.2	4.9 x 18.0	
AGA55	5.5	5.2 x 14.0	
AGA58	5.8	5.5 x 14.0	
AGA61	6.1	5.8 x 14.0	\$1,040.00
AGA64	6.4	6.1 x 14.0	
AGADIYL	Universal to 6.4		



316ST

316ST Marine grade, SAE 316 Stainless Steel

5 star quality - medium to large pools
10 Year pro rata warranty

H 395mm W 485mm T 100mm HW 375mm

Code	Tube (m)	Pool size	Retail Price
316ST40	4.0	3.7 x 18.0	\$981.00
316ST43	4.3	4.0 x 18.0	
316ST46	4.6	4.3 x 18.0	
316STDIYS	Universal to 4.6		
316ST49	4.9	4.6 x 18.0	\$1,070.00
316ST52	5.2	4.9 x 18.0	
316ST55	5.5	5.2 x 14.0	
316ST58	5.8	5.5 x 14.0	
316ST61	6.1	5.8 x 14.0	\$983.00
316ST64	6.4	6.1 x 14.0	
316STDIYL	Universal to 6.4		

ROLLER RANGE - 5 STAR

125mm Roller range for longer wider pools

Note: All rollers are supplied with over cover and cover connection kit. \$25 premium for non standard size fixed length rollers to be manufactured.



125ST Stationary
5 Star quality-For longer wider pools
10 Year pro rata warranty
H 395mm W 485mm T 125mm HW 375mm

Code	Tube (m)	Pool size	Price
125ST40	4.0	3.7 x 20.0	\$1,030.00
125ST43	4.3	4.0 x 20.0	
125ST46	4.6	4.3 x 20.0	
125ST49	4.9	4.6 x 20.0	
125ST52	5.2	4.9 x 20.0	\$1,133.00
125ST55	5.5	5.2 x 18.0	
125ST58	5.8	5.5 x 18.0	
125ST61	6.1	5.8 x 18.0	
125ST64	6.4	6.1 x 18.0	\$1,263.00
125ST67	6.7	6.4 x 18.0	
125ST70	7.0	6.7 x 18.0	



125FM Fully Mobile
5 Star quality-For longer wider pools
10 Year pro rata warranty
H 395mm W 570mm T 125mm HW 375mm

Code	Tube (m)	Pool size	Price
125FM40	4.0	3.7 x 20.0	\$1,055.00
125FM43	4.3	4.0 x 20.0	
125FM46	4.6	4.3 x 20.0	
125FM49	4.9	4.6 x 20.0	
125FM52	5.2	4.9 x 20.0	\$1,165.00
125FM55	5.5	5.2 x 18.0	
125FM58	5.8	5.5 x 18.0	
125FM61	6.1	5.8 x 18.0	
125FM64	6.4	6.1 x 18.0	\$1,298.00
125FM67	6.7	6.4 x 18.0	
125FM70	7.0	6.7 x 18.0	



125MAXI Fully Mobile
5 Star quality-For longer wider pools
10 Year pro rata warranty
H 700mm W 710mm T 125mm HW 375mm

Code	Tube (m)	Pool size	Price
MAXI40	4.0	3.7 x 20.0	\$1714.00
MAXI43	4.3	4.0 x 20.0	
MAXI46	4.6	4.3 x 20.0	
MAXI49	4.9	4.6 x 20.0	
MAXI52	5.2	4.9 x 20.0	\$1825.00
MAXI55	5.5	5.2 x 18.0	
MAXI58	5.8	5.5 x 18.0	
MAXI61	6.1	5.8 x 18.0	
MAXI64	6.4	6.1 x 18.0	\$1957.00
MAXI67	6.7	6.4 x 18.0	
MAXI70	7.0	6.7 x 18.0	

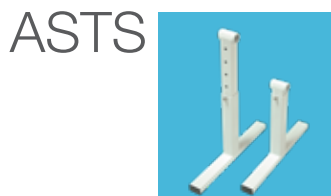

Adjustable ST frame short #236
\$257.35 to make roller heights – 345-395-445-495-545mm.
**Price for 1 frame to adjust roller leg on uneven ground.*



Adjustable ST frame long #237
\$263.70 to make roller heights – 595-645-695-745mm.
**Price for 1 frame to adjust roller leg on uneven ground.*

ROLLER RANGE - UTC

Budget Range

Note: All rollers are supplied with over cover and cover connection kit.



Buddy50
Small pools
5 Year pro rata warranty
H 205mm W 400mm T 50mm

Code	Tube	Pool size	Price
BB50	Universal	3.6 x 7.3	\$294.00



Buddy75
Medium pools
5 Year pro rata warranty
H 205mm W 400mm T 75mm

Code	Tube	Pool size	Price
BB75	Universal	4.2 x 8.0	\$363.00



UTC75
Medium pools
5 Year pro rata warranty
H 310mm W 400mm T 75mm HW 375

Code	Tube	Pool size	Price
UTC75	Universal	4.4 x 12.0	\$442.00

UTC100
Medium to Large pools
5 Year pro rata warranty
H 310mm W 400mm T 100mm HW 375

Code	Tube	Pool size	Price
UTC100	Universal	6.1 x 15.0	\$543.00

UTCAG50
Above Ground Pools
5 Year pro rata warranty
H 75mm W 200mm T 50mm

Code	Tube	Pool size	Price
UTAG50	Universal	4.0 x 8.0	\$294.00

UTCAG75
Above Ground Pools
5 Year pro rata warranty
H 75mm W 200mm T 75mm

Code	Tube	Pool size	Price
UTAG75	Universal	4.4 x 12.0	\$363.00

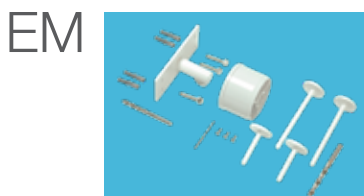

Roller end mount #235
\$144.00 wall mount kit to support one end of the roller.



DAISY POWER

- ✓ Daisy power electric rollers
- ✓ Retro kits available
- ✓ Battery powered AC charge + solar models



ELECTRIC ROLLERS

The standard Daisy Power roller comes as a 12V battery operated electric roller with AC charger, two remotes and control buttons on the cast aluminium housing mounted on the end frame.

Daisy Power has a disengage mechanism, which allows for freewheeling rollout and rollup of the cover, and is a feature unique to Daisy.

Daisy Power can be retrofitted onto most existing 100mm Daisy Rollers.

Warranty period on electrical components (remote/control housing/tube motor/AC charger) is 2 years (this warranty does not cover battery failure). All mechanical parts 10 year pro rata warranty.

Suitable for pools up to 15m.

Daisy Power SQ - Squat Profile



Code	Tube Length (m)	Price NO Solar Panel	Add Solar Panel	
			Code (add to roller code)	Price With Solar Panel
DPSQ1251	Retro Kit - No Tube	\$1,221.50 [^]	DPPV1260	\$1,499.00 [^]
DPSQ40	4.0	\$1,545.50 [^]	DPPV1260	\$1,847.50 [^]
DPSQ43	4.3		DPPV1260	
DPSQ46	4.6		DPPV1260	
DPSQDIYSM	Universal to 4.6	\$1,479.00 [^]	DPPV1260	\$1,716.00 [^]
DPSQ49	4.9	\$1,615.00 [^]	DPPV1260	\$1,922.00 [^]
DPSQ52	5.2		DPPV1260	
DPSQ55	5.5		DPPV1260	
DPSQ58	5.8		DPPV1260	
DPSQ61	6.1		DPPV1260	
DPSQ64	6.4		DPPV1260	
DPSQDIYLG	Universal to 6.4	\$1,533.00 [^]	DPPV1260	\$1,834.00 [^]

Daisy Power ST - Stationary



Code	Tube Length (m)	Price NO Solar Panel	Add Solar Panel	
			Code (add to roller code)	Price With Solar Panel
DPST1250	Retro Kit - No Tube	\$1,221.50 [^]	DPPV1260	\$1,499.00 [^]
DPST40	4.0	\$1,545.50 [^]	DPPV1260	\$1,847.50 [^]
DPST43	4.3		DPPV1260	
DPST46	4.6		DPPV1260	
DPSTDIYSM	Universal to 4.6	\$1,479.00 [^]	DPPV1260	\$1,716.00 [^]
DPST49	4.9	\$1,615.00 [^]	DPPV1260	\$1,922.00 [^]
DPST52	5.2		DPPV1260	
DPST55	5.5		DPPV1260	
DPST58	5.8		DPPV1260	
DPST61	6.1		DPPV1260	
DPST64	6.4	[^]	DPPV1260	
DPSTDIYLG	Universal to 6.4	\$1,533.00 [^]	DPPV1260	\$1,834.00 [^]

Daisy Power WM - Wall Mount



Code	Tube Length (m)	Price NO Solar Panel	Add Solar Panel	
			Code (add to roller code)	Price With Solar Panel
DPWM1255	Retro Kit - No Tube	\$1,286.50 [^]	DPPV1260	\$1,569.00 [^]
DPWM40	4.0	\$1,626.00 [^]	DPPV1260	\$1,934.00 [^]
DPWM43	4.3		DPPV1260	
DPWM46	4.6		DPPV1260	
DPWMDIYSM	Universal to 4.6	\$1,561.00 [^]	DPPV1260	\$1,864.00 [^]
DPWM49	4.9	\$1,691.00 [^]	DPPV1260	\$2,004.00 [^]
DPWM52	5.2		DPPV1260	
DPWM55	5.5		DPPV1260	
DPWM58	5.8		DPPV1260	
DPWM61	6.1		DPPV1260	
DPWM64	6.4		DPPV1260	
DPWMDIYLG	Universal to 6.4	\$1,608.00 [^]	DPPV1260	\$1,915.00 [^]

Daisy Power Parts

Code	Description	Recommended Retail Price
DPPV1260	Solar Panel Kit to clamp to drive motor end frame and plug into control housing to maintain battery power	\$186.25 [^]
DPPOST1262	Post to clamp solar panel to if the power end of the roller is in shade or under cover. (Point end to drive into the ground)	\$136.60 [^]
1215	5m Charge Cable	\$42.45 [^]
1205	AC Charger	\$46.25 [^]
1314	PCB	\$269.00 [^]
1290	Remote Control	\$21.88 [^]
1305	Control housing	\$718.91 [^]
1300	Tube Motor Assembly	\$586.63 [^]
1309	Battery	\$134.00 [^]

For information on Commercial solutions, please contact the Daisy team today.

[^]See Page 29



UBR: UNDER BENCH ROLLER

Front row seating that's stylish and energised!

A pool roller with a difference! The Under Bench Roller (UBR) combines practicality with style by giving you extra poolside seating while keeping the pool roller from view.

All models can be fitted with a solar powered battery option.

- Full aluminium frame and seating with stainless steel hardware
- Seating planks: 2 x 250mm wide planks
- Seating end caps: powder coated cast aluminium
- Power option 12V with solar panel, AC charger, two remotes, tube disengage and mounted control button

- Fully welded and powder coated round aluminium 40mm tubing frame
- Hilti stainless steel anchors
- Small sizes (up to 2.8m pool width) have 1 x C frame support in the middle; large sizes have 2 x C frame supports in the middle
- Able to hold 15m of pool cover material
- 10 year pro rata warranty*
- Custom made to any pool size.

*Scratches and chips not covered. Power model 2 year limited warranty.

Clear Anodised			Standard UBR		Power Version	
Pool Width	Tube Length	Seat Length	Code	Price	Code	Price
2.0	2.2	2.45	UBRCA245	\$1,552.00 [^]	DPUBRCA245	\$2,940.00 [^]
2.5	2.7	2.95	UBRCA295		DPUBRCA295	
2.8	3.0	3.25	UBRCA325		DPUBRCA325	
3.0	3.25	3.5	UBRCA35	\$2,105.00 [^]	DPUBRCA35	\$3,504.00 [^]
3.5	3.75	4.0	UBRCA40		DPUBRCA40	
4.0	4.25	4.5	UBRCA45		DPUBRCA45	
4.5	4.75	5.0	UBRCA50	\$2,105.00 [^]	DPUBRCA50	\$3,504.00 [^]
5.0	5.25	5.5	UBRCA55		DPUBRCA55	
5.5	5.75	6.0	UBRCA60		DPUBRCA60	
6.0	6.25	6.5	UBRCA65		DPUBRCA65	

Charcoal Shimmer			Standard UBR		Power Version	
Pool Width	Tube Length	Seat Length	Code	Price	Code	Price
2.0	2.2	2.45	UBRCS245	\$1,929.00 [^]	DPUBRCS245	\$3,328.00 [^]
2.5	2.7	2.95	UBRCS295		DPUBRCS295	
2.8	3.0	3.25	UBRCS325		DPUBRCS325	
3.0	3.25	3.5	UBRCS35	\$2,697.00 [^]	DPUBRCS35	\$4,098.00 [^]
3.5	3.75	4.0	UBRCS40		DPUBRCS40	
4.0	4.25	4.5	UBRCS45		DPUBRCS45	
4.5	4.75	5.0	UBRCS50	\$2,697.00 [^]	DPUBRCS50	\$4,098.00 [^]
5.0	5.25	5.5	UBRCS55		DPUBRCS55	
5.5	5.75	6.0	UBRCS60		DPUBRCS60	
6.0	6.25	6.5	UBRCS65		DPUBRCS65	

Light Oak			Standard UBR		Power Version	
Pool Width	Tube Length	Seat Length	Code	Price	Code	Price
2.0	2.2	2.45	UBRLO245	\$1,929.00 [^]	DPUBRLO245	\$3,328.00 [^]
2.5	2.7	2.95	UBRLO295		DPUBRLO295	
2.8	3.0	3.25	UBRLO325		DPUBRLO325	
3.0	3.25	3.5	UBRLO35	\$2,697.00 [^]	DPUBRLO35	\$4,098.00 [^]
3.5	3.75	4.0	UBRLO40		DPUBRLO40	
4.0	4.25	4.5	UBRLO45		DPUBRLO45	
4.5	4.75	5.0	UBRLO50	\$2,697.00 [^]	DPUBRLO50	\$4,098.00 [^]
5.0	5.25	5.5	UBRLO55		DPUBRLO55	
5.5	5.75	6.0	UBRLO60		DPUBRLO60	
6.0	6.25	6.5	UBRLO65		DPUBRLO65	

Western Red Cedar			Standard UBR		Power Version	
Pool Width	Tube Length	Seat Length	Code	Price	Code	Price
2.0	2.2	2.45	UBRWRC245	\$1,929.00 [^]	DPUBRWRC245	\$3,328.00 [^]
2.5	2.7	2.95	UBRWRC295		DPUBRWRC295	
2.8	3.0	3.25	UBRWRC325		DPUBRWRC325	
3.0	3.25	3.5	UBRWRC35	\$2,697.00 [^]	DPUBRWRC35	\$4,098.00 [^]
3.5	3.75	4.0	UBRWRC40		DPUBRWRC40	
4.0	4.25	4.5	UBRWRC45		DPUBRWRC45	
4.5	4.75	5.0	UBRWRC50	\$2,697.00 [^]	DPUBRWRC50	\$4,098.00 [^]
5.0	5.25	5.5	UBRWRC55		DPUBRWRC55	
5.5	5.75	6.0	UBRWRC60		DPUBRWRC60	
6.0	6.25	6.5	UBRWRC65		DPUBRWRC65	

BGB: BELOW GROUND POOL COVER BOX

A very popular product, the Below Ground Pool Cover Boxes are suitable for backyards that have limited space. These are a full aluminium constructed box with anodized aluminum lids. Heavy duty braces are fitted to reinforce the structural integrity of the box. Our boxes will save you money not only in protecting your pool cover, giving it longevity but also by enhancing your pool area, adding value to your home.

With Daisy Below Ground Boxes, the power is now in your hands with the latest time-saving accessory - BGB Drill Drive #1425. Find out more below.

- Quality boxes are fitted flush to the paving or concrete height - hidden to enhance the aesthetic look of your pool area
- Slimline lid opening
- Manual roller with sealed 3:1 gearbox and 1.4m handle included
- Single person operation
- Versatile: can be installed to suit most new and existing pools
- Installation only available in selected areas
- 5 year structural warranty for your peace of mind

Manual option pricing

BGB	max pool cover length 20m		
Pool width	BGB Size	Code	RRP
up to 2.5m	3.0m	BGB30	\$4,290.00 [^]
2.55 to 3.0m	3.5m	BGB35	\$4,630.00 [^]
3.05 to 3.5m	4.0m	BGB40	\$4,850.00 [^]
3.55 to 4.0m	4.5m	BGB45	\$5,070.00 [^]
4.05 to 4.5m	5.0m	BGB50	\$5,184.00 [^]
4.55 to 5.0m	5.5m	BGB55	\$5,295.00 [^]
5.05 to 5.5m	6.0m	BGB60	\$5,520.00 [^]

BGBSMall	max pool cover length 9m long		
Pool width	BGB Size	Code	RRP
up to 2.5m	3.0m	BGBSM30	\$3,850.00 [^]
2.55 to 3.0m	3.5m	BGBSM35	\$3,960.00 [^]
3.05 to 3.5m	4.0m	BGBSM40	\$4,185.00 [^]
3.55 to 4.0m	4.5m	BGBSM45	\$4,390.00 [^]

Standard Freight Metro \$170* Non Metro \$397*

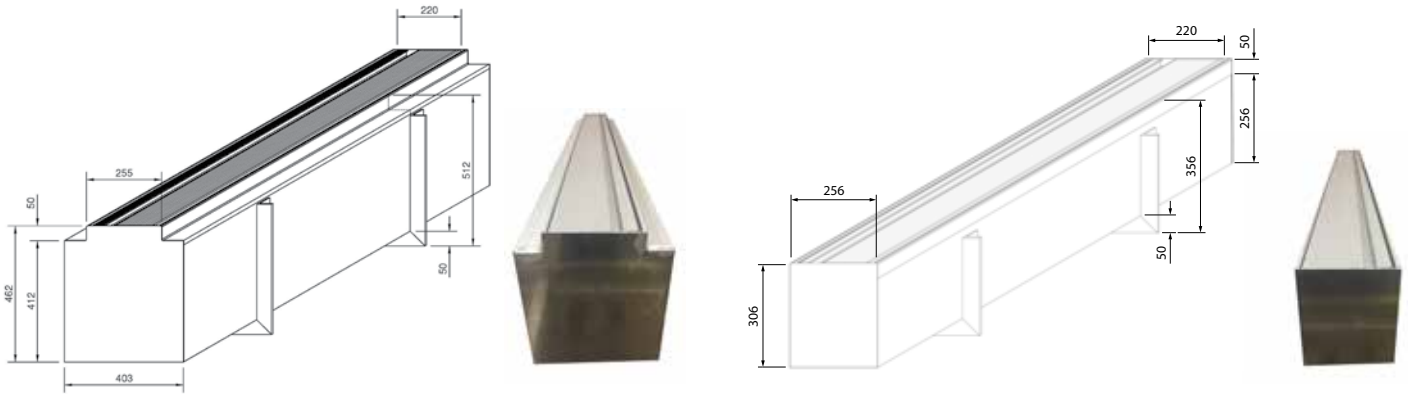

Installation guide download <https://daisypoolcovers.com.au/resources/>

BGB Drill Drive

Code: #1425 (drill not included)
\$485.00

Daisy's super convenient invention allows you to wind up your BGB with a standard power drill. Simply use the extension arm and turn on your drill. Your Daisy Pool Cover will quickly and easily wind into the BGB.

This auto-roller option means no more manual winding. Even better, you can do it all without the hassle of connecting power to your BGB. That's the power of Daisy innovation.



DMR: DECK MOUNT ROLLER

These boxes will not only save you money by protecting your pool cover and giving it longevity, but they also enhance the look of your pool area, adding value to your home. Our units are full aluminium with anodised aluminium lids. Heavy duty braces are fitted to reinforce the structural integrity of the unit.

- Quality units are fitted flush to the decking or paving height – hidden to enhance the aesthetic look of your pool area
- Slimline lid opening
- Single person operation
- Versatile: can be installed to suit most new and existing pool, deck or bricked up cavities
- Installation only available in selected areas
- Note pool cover must be installed to waterline maximum width see FAQ
- 5 year structural warranty for your peace of mind
- Freight Metro: \$105* - Non-Metro: \$240*

Manual option pricing

DMR Deck Mount Roller

Pool width	DMR Size	Code	RRP
up to 2.5m	3.0m	DMR30	\$2,025.00 [^]
2.55 to 3.0m	3.5m	DMR35	\$2,312.00 [^]
3.05 to 3.5m	4.0m	DMR40	\$2,312.00 [^]
3.55 to 4.0m	4.5m	DMR45	\$2,312.00 [^]
4.05 to 4.5m	5.0m	DMR50	\$2,312.00 [^]
4.55 to 5.0m	5.5m	DMR55	\$2,690.00 [^]
5.05 to 5.5m	6.0m	DMR60	\$2,690.00 [^]

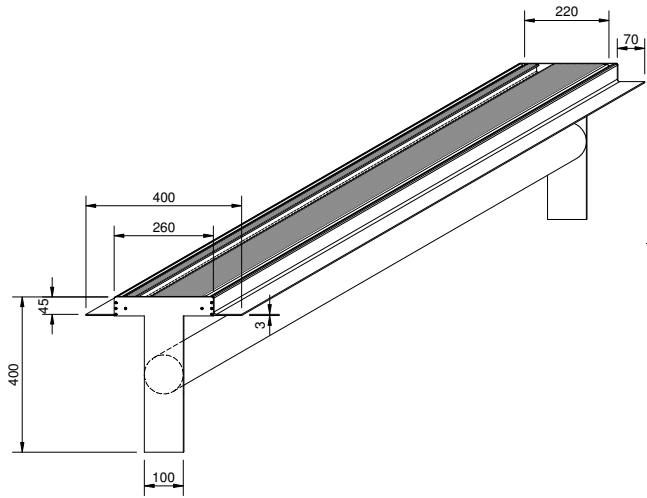

Pit Mount Roller Kit

Code	RRP
PMR46	\$845.00 [^]
PMR60	\$1,097.00 [^]

Kit of roller and drive to mount underground for installations where customer has built lid and or pit structure. Supplied with DIY tube.

[^]See Page 29



COMMERCIAL



COMMERCIAL COVERS AND ROLLERS

Daisy is Australia's largest supplier of pool covers and rollers to the commercial industry. We have been in the pool cover industry for over 39 years.

Our commercial products have the strength and durability to withstand the harsh climate and conditions that an Australian public swimming pool is exposed to.

Our service, expertise and product design and quality produce cost reductions that are multiplied with commercial purchases.

If your operation is considering the cost saving benefits of a Daisy pool cover and roller system, **contact us by phone or email commercial@daisypoolcovers.com.au**

See the Commercial section on daisypoolcovers.com.au



Be water wise

Save over 200,000 litres of water per month (50m pool)



Be energy wise

Save 30-40% energy cost



Be money wise

Daisy will pay for itself in 12 months



DAISY COMMERCIAL COVERS

Our Commercial Pool Cover range includes our two market-leading products:

1. The **525 Solar Cover** using our patented UltraDome™ Technology delivering best-in-class thermal efficiency, unparalleled performance and longevity in the life of the pool cover; and
2. The **ThermoTech™ Thermal Foam Cover**, a 4.5mm thick, cross linked PE closed cell Polyethylene foam pool cover.

Daisy pool covers and roller systems save on a large scale:

1. Saves pool warmth and reduces heating costs by 30-40%
2. Saves on cleaning costs
3. Saves on the cost of chemicals and retains chlorine
4. Reduces evaporation by 99.98%
In practical terms this means you stop water loss when the pool cover is on the water.

Mean Daily Evaporation Rate (in mm) for the October to March 6 month daily average from The Bureau of Meteorology

Sydney	Melbourne	Brisbane	Adelaide	Perth
6.4mm	6.4mm	6.9mm	7.4mm	8.3mm

Example: 50m x 20m outdoor pool in Brisbane loses 207,000 litres of water in a 30 day period in summer due to evaporation

5. Reduces building maintenance, corrosion and condensation in indoor heated pools
6. Extends the swimming season
7. A Daisy will pay for itself in 12 months

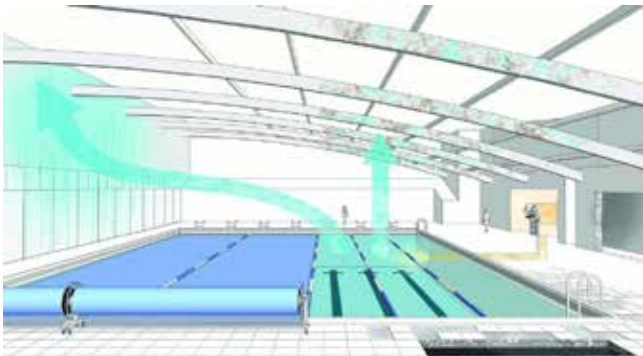

Indoor Pool Evaporation

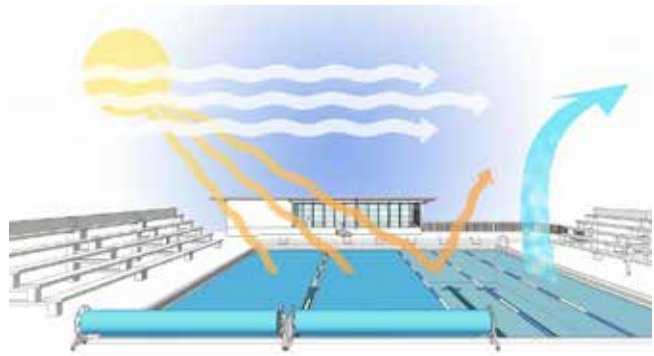

Outdoor Pool Evaporation



525B
Solar pool cover
Translucent Blue
5 Year pro rata warranty
525 micron
Most Effective

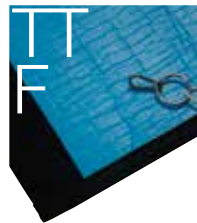

ThermoTech
Foam
Insulation Cover
Blue Opaque
5 Year pro rata warranty
4.5mm
Heated and Indoor



DAISY COMMERCIAL ROLLERS

Daisy Commercial is the problem solver for large and commercial swimming pools. No matter the pool you have the Daisy Commercial team will work with you to find a customised solution that will best suit your business and environment.

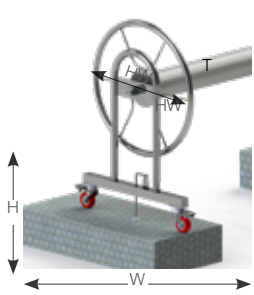

U125

U125 Commercial
Stainless Steel (316) "U" Frame
700mm Stainless Steel Handwheel
125mm x 2.0mm Tube

Code	Tube	Pool size	Price
U125SMB752	upto 5.2	4.9 x 25.0	\$2,545.00 [^]
U125SMB770	upto 7.0	6.7 x 20.0	\$2,666.00 [^]

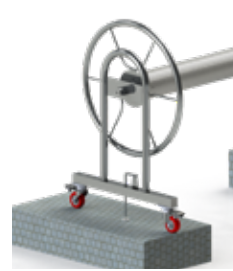

U150

U150 Commercial
Stainless Steel (316) "U" Frame
700mm Stainless Steel Handwheel
152mm x 2.0mm Tube

Code	Tube	Pool size	Price
U150SMB952	upto 5.2	4.9 x 50.0	\$2,824.00 [^]
U150SMB970	upto 7.0	6.7 x 25.0	\$2,973.00 [^]

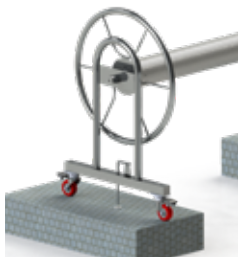

U203

U203 Commercial
Stainless Steel (316) "U" Frame
900mm Stainless Steel Handwheel
203mm x 3.0mm Tube
H 738mm W 985mm T 203mm HW 900

Code	Tube	Pool size	Price
U203SMB952	upto 5.2	4.9 x 50.0	\$3,988.00 [^]
U203SMB970	upto 7.0	6.7 x 50.0	\$4,267.00 [^]

Caddy Pro



Under Bench Rollers



Wall Mounted Rollers



THE EXTRA MILE IN QUALITY AND SERVICE

Over the years, Daisy has covered a lot of pools, refining our processes to make it easier to order, install and use Daisy products. We've also added services, products and finishes providing greater flexibility, and go the extra mile in quality and service.

Minimum charges: \$250 (RRP).

Contact Daisy Pool Covers for any of your Commercial needs.

Service	Cost	per:
Pre Cut (robotic cut for fibreglass pools)	\$71.50*	each
Custom Pre Cut (special measurements)	\$99.00*	each
Wind Skirt per metre	\$25.95^	per lineal metre
Edge Binding (black woven edging)	\$17.15^	per lineal metre
Edge Binding (coloured PVC edging)	\$17.15^	per lineal metre
Float rod, harness haulcord	\$445.00^	each
Dig Template - (up to 7m pool)	\$64.70*	each
Dig Template - (7.1 to 10m pool)	\$75.00*	each
Dig Template - (10.1m + pool)	\$85.50*	each
Caddy Pro	\$11,900.00^	each



Robotic Pre-Cut



Foam cover with step cut out



Foam reinforced roller end (commercial)



Spa cover with PVC coloured edging (commercial)



Foam edge bound



Caddy Pro driving under bench roller



PRICE LIST

\$38.75 per m²

Cover width (finished size)

Length	2m	2.5m	3m	3.5m	4m	4.5m	5m	5.5m	6m	6.5m	Length
2.4	\$186.00	\$232.50	\$279.00	\$325.50	\$372.00	\$418.50	\$465.00	\$511.50	\$558.00	\$604.50	2.4
2.7	\$209.25	\$261.56	\$313.88	\$366.19	\$418.50	\$470.81	\$523.13	\$575.44	\$627.75	\$680.06	2.7
3	\$232.50	\$290.63	\$348.75	\$406.88	\$465.00	\$523.13	\$581.25	\$639.38	\$697.50	\$755.63	3
3.3	\$255.75	\$319.69	\$383.63	\$447.56	\$511.50	\$575.44	\$639.38	\$703.31	\$767.25	\$831.19	3.3
3.6	\$279.00	\$348.75	\$418.50	\$488.25	\$558.00	\$627.75	\$697.50	\$767.25	\$837.00	\$906.75	3.6
3.9	\$302.25	\$377.81	\$453.38	\$528.94	\$604.50	\$680.06	\$755.63	\$831.19	\$906.75	\$982.31	3.9
4.2	\$325.50	\$406.88	\$488.25	\$569.63	\$651.00	\$732.38	\$813.75	\$895.13	\$976.50	\$1,057.88	4.2
4.5	\$348.75	\$435.94	\$523.13	\$610.31	\$697.50	\$784.69	\$871.88	\$959.06	\$1,046.25	\$1,133.44	4.5
4.8	\$372.00	\$465.00	\$558.00	\$651.00	\$744.00	\$837.00	\$930.00	\$1,023.00	\$1,116.00	\$1,209.00	4.8
5.1	\$395.25	\$494.06	\$592.88	\$691.69	\$790.50	\$889.31	\$988.13	\$1,086.94	\$1,185.75	\$1,284.56	5.1
5.4	\$418.50	\$523.13	\$627.75	\$732.38	\$837.00	\$941.63	\$1,046.25	\$1,150.88	\$1,255.50	\$1,360.13	5.4
5.7	\$441.75	\$552.19	\$662.63	\$773.06	\$883.50	\$993.94	\$1,104.38	\$1,214.81	\$1,325.25	\$1,435.69	5.7
6.1	\$472.75	\$590.94	\$709.13	\$827.31	\$945.50	\$1,063.69	\$1,181.88	\$1,300.06	\$1,418.25	\$1,536.44	6.1
6.4	\$496.00	\$620.00	\$744.00	\$868.00	\$992.00	\$1,116.00	\$1,240.00	\$1,364.00	\$1,488.00	\$1,612.00	6.4
6.7	\$519.25	\$649.06	\$778.88	\$908.69	\$1,038.50	\$1,168.31	\$1,298.13	\$1,427.94	\$1,557.75	\$1,687.56	6.7
7	\$542.50	\$678.13	\$813.75	\$949.38	\$1,085.00	\$1,220.63	\$1,356.25	\$1,491.88	\$1,627.50	\$1,763.13	7
7.3	\$565.75	\$707.19	\$848.63	\$990.06	\$1,131.50	\$1,272.94	\$1,414.38	\$1,555.81	\$1,697.25	\$1,838.69	7.3
7.6	\$589.00	\$736.25	\$883.50	\$1,030.75	\$1,178.00	\$1,325.25	\$1,472.50	\$1,619.75	\$1,767.00	\$1,914.25	7.6
7.9	\$612.25	\$765.31	\$918.38	\$1,071.44	\$1,224.50	\$1,377.56	\$1,530.63	\$1,683.69	\$1,836.75	\$1,989.81	7.9
8.2	\$635.50	\$794.38	\$953.25	\$1,112.13	\$1,271.00	\$1,429.88	\$1,588.75	\$1,747.63	\$1,906.50	\$2,065.38	8.2
8.5	\$658.75	\$823.44	\$988.13	\$1,152.81	\$1,317.50	\$1,482.19	\$1,646.88	\$1,811.56	\$1,976.25	\$2,140.94	8.5
8.8	\$682.00	\$852.50	\$1,023.00	\$1,193.50	\$1,364.00	\$1,534.50	\$1,705.00	\$1,875.50	\$2,046.00	\$2,216.50	8.8
9.1	\$705.25	\$881.56	\$1,057.88	\$1,234.19	\$1,410.50	\$1,586.81	\$1,763.13	\$1,939.44	\$2,115.75	\$2,292.06	9.1
9.4	\$728.50	\$910.63	\$1,092.75	\$1,274.88	\$1,457.00	\$1,639.13	\$1,821.25	\$2,003.38	\$2,185.50	\$2,367.63	9.4
9.7	\$751.75	\$939.69	\$1,127.63	\$1,315.56	\$1,503.50	\$1,691.44	\$1,879.38	\$2,067.31	\$2,255.25	\$2,443.19	9.7
10	\$775.00	\$968.75	\$1,162.50	\$1,356.25	\$1,550.00	\$1,743.75	\$1,937.50	\$2,131.25	\$2,325.00	\$2,518.75	10
10.3	\$798.25	\$997.81	\$1,197.38	\$1,396.94	\$1,596.50	\$1,796.06	\$1,995.63	\$2,195.19	\$2,394.75	\$2,594.31	10.3
10.6	\$821.50	\$1,026.88	\$1,232.25	\$1,437.63	\$1,643.00	\$1,848.38	\$2,053.75	\$2,259.13	\$2,464.50	\$2,669.88	10.6
10.9	\$844.75	\$1,055.94	\$1,267.13	\$1,478.31	\$1,689.50	\$1,900.69	\$2,111.88	\$2,323.06	\$2,534.25	\$2,745.44	10.9
11.2	\$868.00	\$1,085.00	\$1,302.00	\$1,519.00	\$1,736.00	\$1,953.00	\$2,170.00	\$2,387.00	\$2,604.00	\$2,821.00	11.2
11.5	\$891.25	\$1,114.06	\$1,336.88	\$1,559.69	\$1,782.50	\$2,005.31	\$2,228.13	\$2,450.94	\$2,673.75	\$2,896.56	11.5
11.9	\$922.25	\$1,152.81	\$1,383.38	\$1,613.94	\$1,844.50	\$2,075.06	\$2,305.63	\$2,536.19	\$2,766.75	\$2,997.31	11.9
12.2	\$945.50	\$1,181.88	\$1,418.25	\$1,654.63	\$1,891.00	\$2,127.38	\$2,363.75	\$2,600.13	\$2,836.50	\$3,072.88	12.2
Length	2m	2.5m	3m	3.5m	4m	4.5m	5m	5.5m	6m	6.5m	Length

Insulating cover that does not heat the water. Ideal to assist keeping leaves and dirt out, stop evaporation and condensation without increasing water temperature.

4.5mm cross linked PE closed cell Polyethylene Foam. 3 layers, flame bonded both sides to UV stabilized, water proof, non toxic and chemical resistant blue woven PE.

All thermal foam covers are tape welded both sides. Step areas can be added by welding small rectangles on sides of the cover.

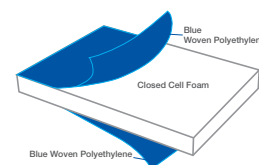

RRP Including GST. Please Note: Price Matrix is approx cover size. Allow for cover min 200mm larger all sides (200mm each end + each side = cover 400mm larger than pool).

Cover width (finished size)

Length	1.6m	2.5m	3.4m	4.3m	5.2m	6.1m	7m		
Cover length (finished size)	2.5	\$306.24	\$349.38					2.5	
	3	\$367.49	\$419.25	\$475.73				3	
	3.5	\$428.74	\$489.13	\$555.02	\$613.89			3.5	
	4	\$489.98	\$559.00	\$634.30	\$701.59			4	
	4.5	\$551.23	\$628.88	\$713.59	\$789.29	\$862.06		4.5	
	5	\$612.48	\$698.75	\$792.88	\$876.99	\$957.84		5	
	5.5	\$673.73	\$768.63	\$872.17	\$964.68	\$1,053.62	\$1,153.11	5.5	
	6	\$734.98	\$838.50	\$951.46	\$1,052.38	\$1,149.41	\$1,257.94	6	
	6.5	\$796.22	\$908.38	\$1,030.74	\$1,140.08	\$1,245.19	\$1,362.77	\$1,462.83	6.5
	7	\$857.47	\$978.25	\$1,110.03	\$1,227.78	\$1,340.98	\$1,467.60	\$1,575.35	7
	7.5	\$918.72	\$1,048.13	\$1,189.32	\$1,315.48	\$1,436.76	\$1,572.43	\$1,687.88	7.5
	8	\$979.97	\$1,118.00	\$1,268.61	\$1,403.18	\$1,532.54	\$1,677.26	\$1,800.40	8
	8.5	\$1,041.22	\$1,187.88	\$1,347.90	\$1,490.87	\$1,628.33	\$1,782.08	\$1,912.93	8.5
	9	\$1,102.46	\$1,257.75	\$1,427.18	\$1,578.57	\$1,724.11	\$1,886.91	\$2,025.45	9
	9.5	\$1,163.71	\$1,327.63	\$1,506.47	\$1,666.27	\$1,819.90	\$1,991.74	\$2,137.98	9.5
	10	\$1,224.96	\$1,397.50	\$1,585.76	\$1,753.97	\$1,915.68	\$2,096.57	\$2,250.50	10
	10.5	\$1,286.21	\$1,467.38	\$1,665.05	\$1,841.67	\$2,011.46	\$2,201.40	\$2,363.03	10.5
	11	\$1,347.46	\$1,537.25	\$1,744.34	\$1,929.37	\$2,107.25	\$2,306.23	\$2,475.55	11
11.5	\$1,408.70	\$1,607.13	\$1,823.62	\$2,017.07	\$2,203.03	\$2,411.06	\$2,588.08	11.5	
12	\$1,469.95	\$1,677.00	\$1,902.91	\$2,104.76	\$2,298.82	\$2,515.88	\$2,700.60	12	
12.5	\$1,531.20	\$1,746.88	\$1,982.20	\$2,192.46	\$2,394.60	\$2,620.71	\$2,813.13	12.5	
13	\$1,592.45	\$1,816.75	\$2,061.49	\$2,280.16	\$2,490.38	\$2,725.54	\$2,925.65	13	
13.5	\$1,653.70	\$1,886.63	\$2,140.78	\$2,367.86	\$2,586.17	\$2,830.37	\$3,038.18	13.5	
14	\$1,714.94	\$1,956.50	\$2,220.06	\$2,455.56	\$2,681.95	\$2,935.20	\$3,150.70	14	
14.5	\$1,776.19	\$2,026.38	\$2,299.35	\$2,543.26	\$2,777.74	\$3,040.03	\$3,263.23	14.5	
15	\$1,837.44	\$2,096.25	\$2,378.64	\$2,630.96	\$2,873.52	\$3,144.86	\$3,375.75	15	
15.5	\$1,898.69	\$2,166.13	\$2,457.93	\$2,718.65	\$2,969.30	\$3,249.68	\$3,488.28	15.5	
Length	1.6m	2.5m	3.4m	4.3m	5.2m	6.1m	7m		
M ² price by width	\$76.56	\$55.90	\$46.64	\$40.79	\$36.84	\$34.37	\$32.15		

BK

BL

GR

GY

TN

Fitting Set



Deck Fitting Option

In Ground Option

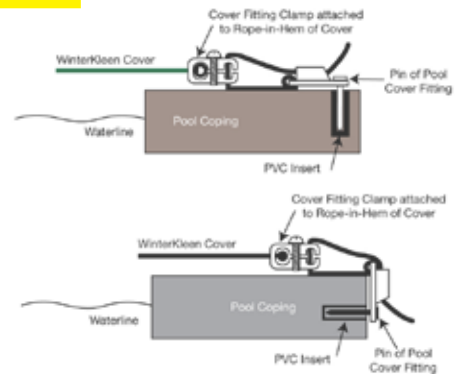

Storage bag included

Daisy Float WT206 \$13.20 each

Float cord 25m (6mmPP to tie floats in place)
#415 - \$12.65

Handrail cut outs - extra \$79.00*

Sufficient fitting sets are supplied with every cover to be installed approx 800mm apart.

All covers are custom made so unfortunately we are unable to take any cover back for credit.

Minimum cover price -\$300

For step areas simply add step size to cover size.

Fitting Set \$9.65 - #138BK - Black, 138CR - Cream, 138TE - Terracotta

Standard ground insert only. Codes: 276 - Black, 420 - Cream, 419 - Terracotta

Deck fittings instead of normal in ground fitting + \$2.85 per fitting.

Codes: 435 - Black, 436 - Cream, 437 - Terracotta

Not suitable for empty pools.

For special shaped pools that can not be covered with rectangles, please see how to measure page 25 or our website.



Recommended Retail install pricing guide.

Cover Size	Price
up to 20m ² :	\$245.00*
21m ² to 25m ² :	\$302.00*
26m ² to 35m ² :	\$357.00*
36m ² to 50m ² :	\$429.00*
51m ² to 60m ² :	\$462.00*
61m ² to 70m ² :	\$540.00*
71m ² +:	\$605.00*

Pool areas may have uneven surrounds or have hollows under the pavers or tiles. Installers cannot be liable for chipped surfaces or cracked pavers

*See Page 29

WKAG WINTERKAP WinterKleen for above ground pools

Top quality protection for above ground pools. Same material as WinterKleen (p21). Shock cord supplied to easily help keep WinterKap in place on above ground pools. 8 year pro rata warranty.

Note: Price is approx WinterKap finished size - normal cover size required is pool size + 400mm each side

Length	3.4m	4.3m	5.2m	6.1m	7m	
3.5	\$290.00					3.5
4	\$331.43					4
4.5	\$372.86	\$444.47				4.5
5	\$414.29	\$493.86				5
5.5	\$455.72	\$543.24	\$620.05			5.5
6	\$497.15	\$592.63	\$676.42	\$754.69		6
6.5	\$538.58	\$642.01	\$732.78	\$817.58		6.5
7	\$580.01	\$691.40	\$789.15	\$880.47	\$964.81	7
7.5	\$621.44	\$740.78	\$845.52	\$943.37	\$1,033.73	7.5
8	\$662.86	\$790.17	\$901.89	\$1,006.26	\$1,102.64	8
8.5	\$704.29	\$839.55	\$958.26	\$1,069.15	\$1,171.56	8.5
9	\$745.72	\$888.94	\$1,014.62	\$1,132.04	\$1,240.47	9
9.5	\$787.15	\$938.32	\$1,070.99	\$1,194.93	\$1,309.39	9.5
10	\$828.58	\$987.71	\$1,127.36	\$1,257.82	\$1,378.30	10
10.5	\$870.01	\$1,037.10	\$1,183.73	\$1,320.71	\$1,447.22	10.5
11	\$911.44	\$1,086.48	\$1,240.10	\$1,383.60	\$1,516.13	11
11.5	\$952.87	\$1,135.87	\$1,296.46	\$1,446.49	\$1,585.05	11.5
12	\$994.30	\$1,185.25	\$1,352.83	\$1,509.38	\$1,653.96	12
12.5	\$1,035.73	\$1,234.64	\$1,409.20	\$1,572.28	\$1,722.88	12.5
13	\$1,077.15	\$1,284.02	\$1,465.57	\$1,635.17	\$1,791.79	13
13.5	\$1,118.58	\$1,333.41	\$1,521.94	\$1,698.06	\$1,860.71	13.5
14	\$1,160.01	\$1,382.79	\$1,578.30	\$1,760.95	\$1,929.62	14
14.5	\$1,201.44	\$1,432.18	\$1,634.67	\$1,823.84	\$1,998.54	14.5
15	\$1,242.87	\$1,481.57	\$1,691.04	\$1,886.73	\$2,067.45	15
15.5	\$1,284.30	\$1,530.95	\$1,747.41	\$1,949.62	\$2,136.37	15.5
Length	3.4m	4.3m	5.2m	6.1m	7m	
Mf price by width	\$24.37	\$22.97	\$21.68	\$20.62	\$19.69	

Daisy Float

WT206 \$13.85 each

Size 0.75m x 0.75m up to 0.3m

To raise cover above edge of pool to help prevent debris build up.

1-2 floats per 5m of pool length may be required.

Float Cord 25m (6mm PP to tie floats in place) #415 \$12.65



BUDGET SPA FOAM COVERS

All Spa sheets supplied rectangular 1.0m wide to be cut to spa waterline shape on site

12 month pro rata warranty

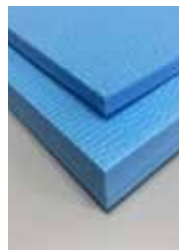

Spa Cover Size

- 2.0 x 2.0
- 2.5 x 2.5
- 3.0 x 2.0
- 3.0 x 2.5
- 3.0 x 3.0
- 3.5 x 2.5
- 4.0 x 2.0

10mm Foam R-Value 0.32

- \$193.92
- \$303.00
- \$290.88
- \$363.60
- \$436.32
- \$424.20
- \$387.84

20mm Foam R-Value 0.64

- \$349.04
- \$545.38
- \$523.56
- \$654.45
- \$785.34
- \$763.53
- \$698.08

How the spa cover is supplied

- 2 sheets @ 2m
- 2.5 sheets @ 2.5m
- 3 sheets @ 2m
- 3 sheets @ 2.5m
- 3 sheets @ 3m
- 3.5 sheets @ 2.5m
- 4 sheets @ 2m



All Daisy Pool Covers carry the national Smart Approved WaterMark Approval and Climate Care certification.



HOW TO MEASURE A WINTERKLEEN COVER

□ A – B Length =

□ C – D Length =

□ Last Point Before B =

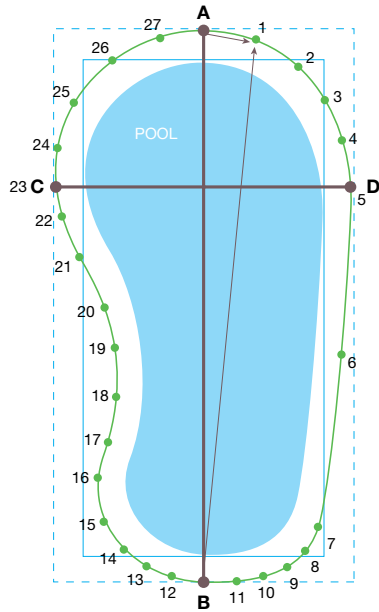

Billing Details:

Date / /

Business Name:

Contact:

For. Name:

Deliver to:

Contact No.:

Street Address:

1 Rectangle - - - - - Indicates Rectangular Cover
Measure finished cover size length and width.

2 Shaped □□□ Indicates Curvilinear Measuring:

- Chalk mark two points □ A and □ B at the longest point 200mm from the edge of the pool. (Record total width and length)
- Chalk mark and number a series of □ points 200mm out from pool edge, □ 1, □ 2, □ 3 etc. starting **clockwise** from □ A all around to □ B about 900mm apart. Closer on tighter curves further apart for straighter edges.

3 Measure the distances from □ A to marked □ all points and record the distance to every chalk marked. eg □ A to □ 1 = 957mm or 95.7 cm

4 Measure the distances from □ B to marked □ points and record the distance to every chalk marked. eg □ B to □ 1 = 8500mm or 850cm

5 Draw a sketch of the pool outline (like the one on left) indicating approximate location of points A and B and the points between.

6 Fax or email to us your measurements in the table below.

The same method and measurements will be used to make the cover.

NOTE: This measuring procedure applies only to curvilinear pools. If you measure counter clockwise from 'A' the cover will be manufactured upside down.

Draw a sketch of the plan. Include a photo image if possible.

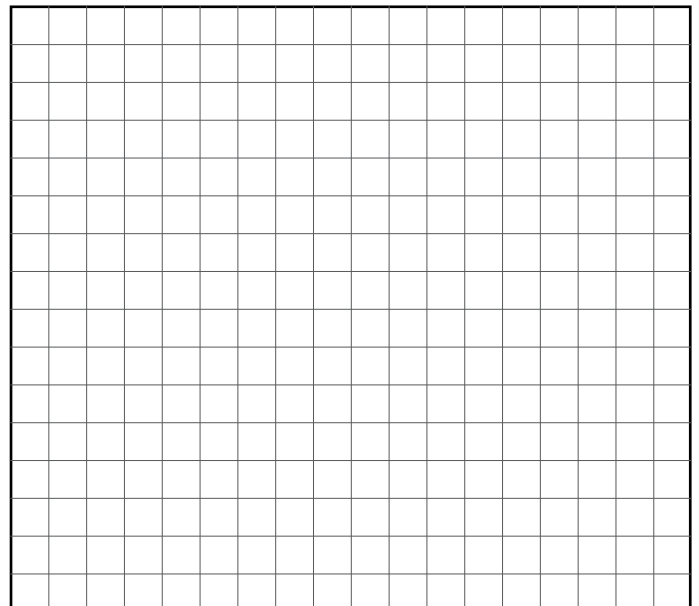

From □ A b	□	a From □ B
eg 850 mm	1	eg 10850 mm
	2	
	3	
	4	
	5	
	6	
	7	
	8	
	9	
	10	
	11	
	12	
	13	
	14	
	15	
	16	
	17	
	18	
	19	
	20	

From □ A b	□	a From □ B
eg 10850 mm	21	eg 850 mm
	22	
	23	
	24	
	25	
	26	
	27	
	28	
	29	
	30	
	31	
	32	
	33	
	34	
	35	
	36	
	37	
	38	
	39	
	40	

WinterKleen Colour: Black Blue Green Grey Tan

ROLLER PARTS AND ACCESSORIES

ITEM	Part#	Price
5 Star 316ST T Frame (each)	253	\$229.59
5 Star AGA Frame (each)	212	\$335.35
5 Star A75 Frame (each) White	214	\$127.27
5 Star A75 Frame (each) Black	446	\$127.27
5 Star A75 Frame (each) Grey	454	\$127.27
5 Star Bearing (pair) White	P018	\$5.19
5 Star Bearing (pair) Black	449	\$5.19
5 Star Bearing (pair) Grey	457	\$5.19
5 Star FM Mobile T Frame (each)	101	\$244.49
5 Star LP Mobile T Frame (each)	102	\$237.26
5 Star MKII Mobile T-Frame (each) White	P026	\$223.27
5 Star MKII Mobile T-Frame (each) Black	448	\$223.27
5 Star MKII Mobile T-Frame (each) Grey	456	\$223.27
5 Star SQ Stationary Frame (each)	239	\$159.83
5 Star ST T-Frame (each) White	P024	\$186.64
5 Star ST T-Frame (each) Black	447	\$186.64
5 Star ST T-Frame (each) Grey	455	\$186.64
Bonded Washer	P049	\$0.67
Carabiner Clip	130	\$5.37
Castor Assembly (Body/Screw/Nut/Washer)	119	\$36.89
Castor Body only	118	\$7.59
Commercial Castor 100mm (Braked)	121	\$130.26
Cord (2.0m each)	P043	\$1.57
Crank (Buddy)	P020	\$37.31
End Cap	P008	\$5.25
End Slug with Axle 75mm	P006	\$28.78
End Slug with Axle 79mm	251	\$28.78
End Slug with Axle 95mm	252	\$32.90
End Slug with Axle 100mm	P007	\$32.90
End Slug with Axle 125mm	105	\$40.92
End Slug with Axle 125mm Maxi	120	\$43.57
Eyelet Kit = 10 x eyelets 1 x punch	1007	\$9.71
Eyelet Punch	P013	\$3.61
Eyelet Pair (blue)	P012	\$0.61
Eyelet Pair (green)	225	\$0.61
Eyelet Pair (white)	229	\$0.61
Feather Plug	P011	\$0.61

ITEM	Part#	Price
Foot UTC	P001	\$32.06
Handwheel UTC	P005	\$37.19
Handwheel Stainless Steel	254	\$114.79
Handwheel 5 Star White	P048	\$50.91
Handwheel 5 Star Black	452	\$50.91
Handwheel 5 Star Grey	460	\$50.91
Haul Cord 10 metre	131	\$19.02
Haul Cord 15 metre	132	\$27.49
Haul Cord 20 metre	133	\$35.95
Leg & Leg Top UTC	P004	\$29.29
Leg Only UTC	P002	\$18.40
Leg Top Only UTC	P003	\$10.89
Occy Strap UTC	P016	\$11.29
Overcover Ball	126	\$0.82
Overcover strap (Holds cover in high wind)	324	\$20.09
Overcover up to 4.6m (Size req. for 5 star)	OC054	\$73.59
Overcover up to 6.4m (Size req. for 5 star)	OC055	\$88.49
Overcover up to 6.5m to 7.9m (Size req.)	OC091	\$112.54
Refit Kit (Cover to roller connection kit)	P092	\$30.70
Repair Patch (A4 size)	-	\$33.75
Rubber Non Slip Stopper UTC	P009	\$0.90
Rubber Stopper ST Frame	P030	\$4.56
Sand Change Bag	-	\$22.97*
Scissors	215	\$62.08
Shock Cord	228	\$9.43
Slide Clip	129	\$2.43
Spring Loaded Adjuster	127	\$1.24
Stainless Steel Screw	P010	\$0.90
Stainless Steel Self Drilling Screw	248	\$1.07
Washer and bolt (end slug retaining) White	243	\$2.88
Washer and bolt (end slug retaining) Black	450	\$2.88
Washer and bolt (end slug retaining) Grey	458	\$2.88
Yoke & Pin	P019	\$24.38

Pool and cover maintenance products	Part#	500ml	Part#	1L
Aquasaver	376	\$34.65	375	\$65.45
		500ml with trigger spray		-
Bio Pool Cover Cleaner	377	\$34.65		-
Pool Cover Cleaner – Head & Refill			373	\$65.45
Pool Cover Cleaner – Refill only			374	\$34.65



375
AquaSaver



377
Bio Pool
Cover
Cleaner



373
Pool
Cover
Cleaner



End Slug

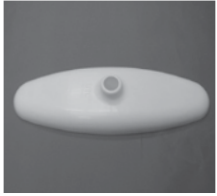

P001
Foot UTC



P003
Leg Top



P004
Leg & legtop
UTC



P005
Handwheel
UTC



P008
End Cap

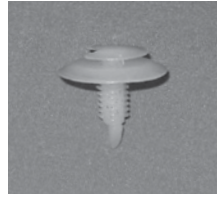

P011
Feather Plug

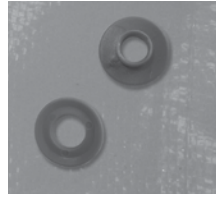

P012
Eyelet (Pair)



P018
5-Star Bearing



P019
Yoke & Pin



P020
Crank



P048
Handwheel
5-Star



P092
Refit Kit



P054
5 Star
Overcover



119
Mobile
Castor
Assembly



121
Commercial
Castor
100mm

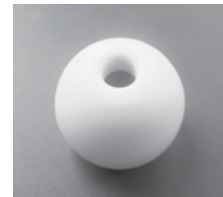

126
Overcover
Ball

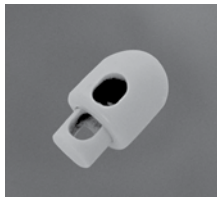

127
Spring
Loaded
Adjuster



215
Upholstering
Scissors



324
Overcover Strap



1007
Eyelet Kit

Installation

Net Pricing - No Discount Applies	National	Sydney	Perth
Pre Cut	\$71.50*		
Pre Cut Custom (from)	\$99.00*		
Pool cover or roller (1 Item)		\$220.00*	\$130.00*
Pool cover and roller (2 Items)		\$385.00*	\$225.00*
UBR and pool cover		\$550.00*	\$320.00*
Call Out (Measure Service)		\$155.00*	\$80.00*

ROLLER DIMENSIONS

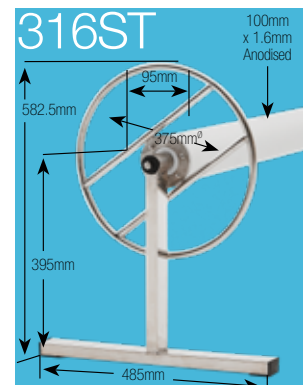
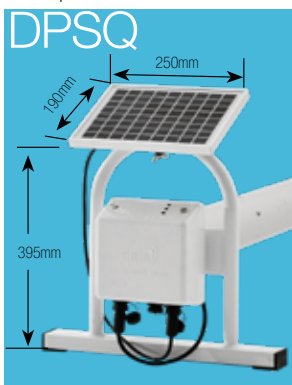
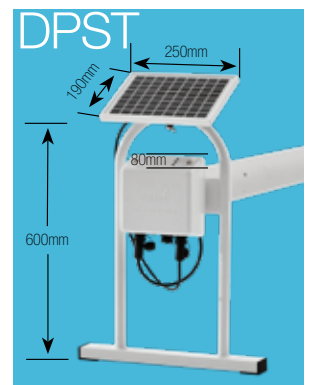
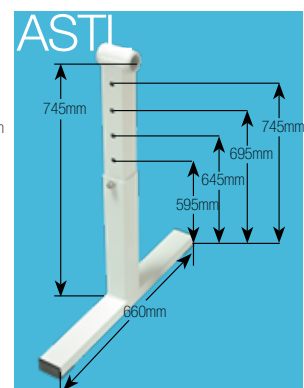
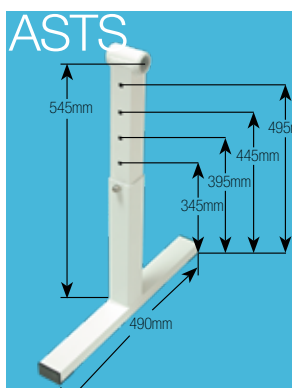
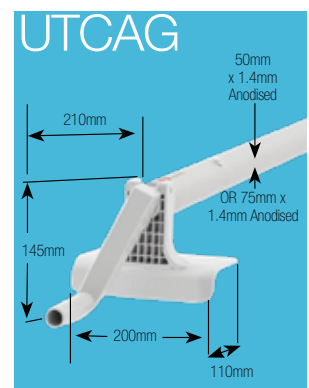
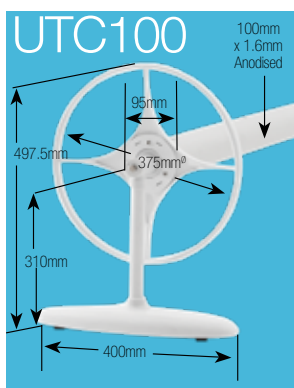
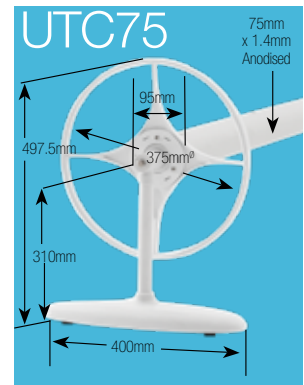
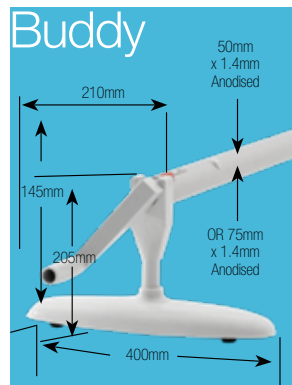
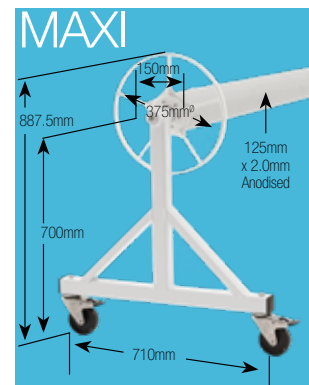
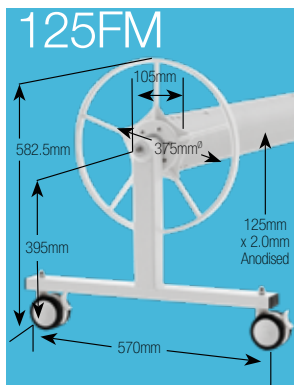
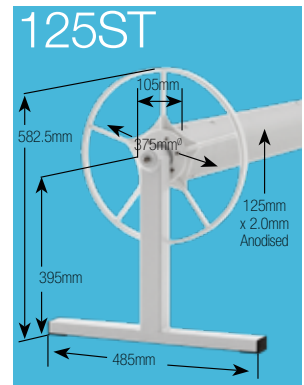
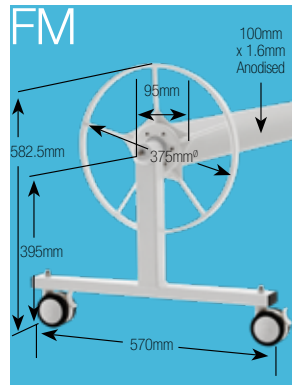
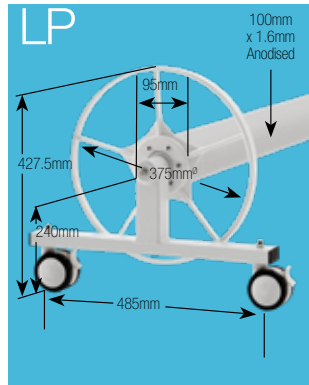
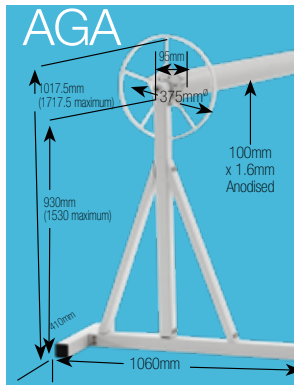
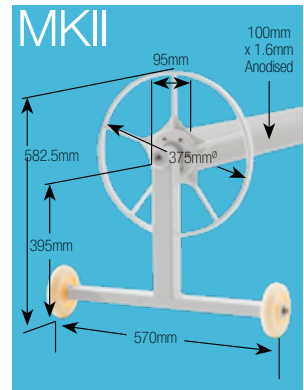
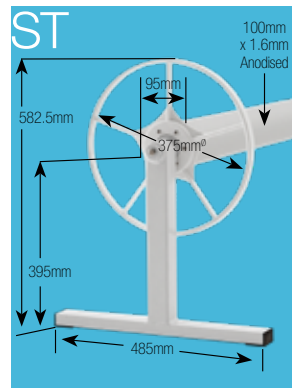
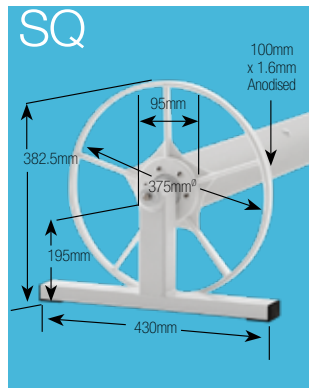
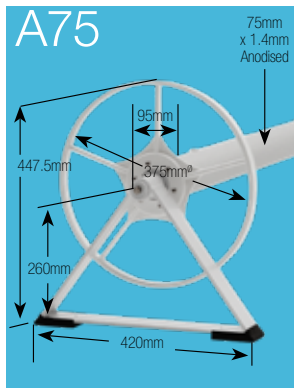

Restocking Policy - Cover

If you require a return of a domestic cover or if a cover size that is ordered and supplied correctly turns out to be the incorrect size for the pool, a few scenarios are available.

1

If the cover is too narrow (on the width of the pool), then when the cover is delivered back to either of the Daisy's factories in WA or NSW, Daisy will be able to weld onto the width of the cover to make it wider. Daisy will only charge for the material used to weld onto the existing cover. Please note minimum fee of \$50.00 plus GST applies for repair work. NOTE – if the cover has been cut to shape it is likely that by welding on a section it will distort and shrink the edge of the cover rendering it too small. Daisy accepts no responsibility for attempted repairs after the cover has been cut in to pool shape. After approximately one month the cover can lose its "weld ability" therefore we may attempt to assist, however take no responsibility of failed repair attempts.

2

If the cover is too short (on the length of the pool) we can not cross weld satisfactorily across the cover and a new cover will be required.

3

If the cover is DRY, meaning it has not been rolled onto the pool (NOT meaning a cover rolled onto the pool then removed and dried out), then when the cover is delivered back to either of the Daisy factories in WA or NSW, Daisy will credit the cover MINUS 20% of the non taxed original invoice amount.

4

If the cover has been on a pool and is wet and has not been cut to shape, and has been dried as much as possible, then when the cover is delivered back to either of the Daisy factories in WA or NSW, Daisy will credit the cover MINUS 40% of the non taxed original invoice amount.

5

If the cover has been on a pool and has been cut to shape, or over three months have passed from the original invoice date, Daisy is unable to accept the cover back for any form of credit.

6

Any replacement cover will be invoiced for dispatch and normal freight policy applies, credits will be issued upon receipt and inspection of the cover at the Daisy factories in WA or NSW. Any redelivery of covers repaired and/or altered will incur a freight charge.

Restocking Policy - Precut Cover

As pre cut covers are custom made to order Daisy Pool Covers cannot accept returns for credit.

Restocking Policy - Roller

If a domestic roller requires return for credit and it is a stock size, (not a specially manufactured size – specially manufactured rollers and rollers that have been purchased more than three months before the return date will not be accepted for a credit), still in its original unopened packaging, then when the roller is delivered back to either of the Daisy factories in WA or NSW undamaged, Daisy will credit the amount of the original invoice.

NOTE – All parts of the roller are required and must be unused, undamaged, unassembled and in the original packaging to be eligible for a credit. Credits will be issued upon receipt and inspection of the roller at the Daisy factories in WA or NSW.

Cover Warranty

All Daisy Pool Covers are covered by our exclusive pro rata month by month warranty to the original consumer. This means that Daisy Pool Covers will credit for the months that the original consumer does not achieve from their cover (up to the warranty period).

i.e.

3 years (36 months) for 250B, 5 years (60 months) for 400B, 8 years (96 months) or 10 years (120 months) for 525. It also means that the consumer must pay for the period of time that they have used the product when ordering a replacement cover.
Example: A consumer achieves 3 years, 9 months (45 months) from a 400B cover. Take today's retail price (say \$436.00), divide the price by warranty period in months then multiply by the months the consumer used the cover (IE \$436.00 (retail Price) ÷ 60 months (Warranty period) = \$7.27 (per month price), then multiply \$7.27 (per month price) by 45 (months consumer used product) = \$327.15 charged to client.

Warranty Claims

To make warranty claims contact Daisy with photos and proof of purchase.

All warranty claims where the original consumer has achieved over 66% (2/3rds) of the life of the cover (warranty period) the warranty claim can be handled by the reseller. Daisy Pool Covers will cover the warranty by reducing the purchase price to the reseller, (using the same formula as above) to ensure resellers receive normal margin while handling the warranty claim. Daisy Pool Covers will guide the warranty procedure and authorise warranty claims via phone after the reseller's inspection of the cover. If any reseller is uneasy handling a warranty claim, Daisy Pool Covers will take over and handle the claim direct with the consumer.

Any warranty claim where the consumer has not achieved 66% (2/3rds) of the life of the cover (warranty period) Daisy Pool Covers must handle direct with the client. In all cases it is the responsibility of the consumer to produce a proof of purchase showing date purchased and series of cover. Please Note – Warranty claims are only redeemable as a discount on the purchase of a replacement cover. No cash payments will be made.

Freight Warranty

Our policy is to get the product to you in the most cost effective manner possible. We do not apply margin or profit to freight charges. We reserve the right to pass on any excess costs involved in getting the product to you. It is advisable to ensure that you understand the total cost of the product and add the relevant tax and freight components prior to quoting a price to your client. Our staff are always willing to give you these total costs at any time on any job.

Metro Delivery Time for standard domestic covers and rollers is approximately 2-3 working days, country areas add 1-2 extra working days.

Unless otherwise stated, all prices are free into store in Perth, Sydney, Melbourne, Brisbane, Canberra & Adelaide Metropolitan areas

All other deliveries will incur a lower cost per item when you arrange multiple order deliveries to a single delivery point. Postcode range available.

	Non Metro*	
	Zone 1	Zone 2
Cover or Roller - 1 item	\$31.50	\$74.40
2 Items	\$46.30	\$112.48
3-6	\$59.20	\$139.60
7-9	\$72.70	\$171.70
10+ items	\$88.83	\$209.80

All freight prices quoted are Inc. GST.

Parts Freight*

Small item (FRSM)	\$17.50
Medium item (FRME)	\$21.90
Large item (FRLG)	\$31.50

Long length surcharge

Long length surcharge of \$75.00 inc GST applies to all fixed length rollers supplied over 6.5m. Surcharge applied regardless of delivery location, surcharge is additional to any other delivery charges.

Minimum Cover Size

Single order cover size for Solar Covers is 5.76m² (ie: 2.4 x 2.4m) and for Thermotech Foam 4.8m² (ie: 2.0 x 2.4m). Any single cover orders smaller than these sizes will be charged at these amounts.

Minimum Order

Minimum order: A minimum invoice value of \$75.00 before tax is required to avoid a freight charge. Any total invoice amount under \$75.00 before GST will be subjected to an additional freight charge as follows:

Single Parts from \$17.50* Inc. GST
Any other goods 1 item charge

Net Pricing*

Products such as freight, installation, precut or dig templates that are marked with * indicate net pricing where no discount is applied.

Level 2 Discount Structure^

Some products from Daisy are priced at a non standard speciality discount structure. Where you see ^ by a recommended retail price, trade discount varies from normal discount structure. Contact Daisy for more information.

NOTES:

Unless specifically and clearly requested, all pool covers are made panel Width (panels wide for narrowest measurement) by Length (panels long for longest measurement).

If any specific manufacture requests are made a diagram is required.

Pool covers are made to fit measurements supplied NOT for specific orientations of panels.

Technical Information

For all other information go to 'Help & Advice' on our website.

daisypoolcovers.com.au



REDUCE THE COST OF MAINTAINING A WARM SUSTAINABLE POOL.

Here's how you save:

- SAVE more of the sun's warmth.** Warms your pool by up to 8°C for free.
- SAVE on water, up to 10,000L per month.** Improves water retention.
- SAVE on heat loss.** Reduced heating costs and heat loss.
- SAVE on cleaning.** Helps keep out dirt and leaves.
- SAVE on chemicals.** Reduce salt and chemical use by up to 50%.
- SAVE on time.** Rolls off and on in 30 seconds.
- SAVE on evaporation.** Reduces evaporation by 97%.
- SAVE money** Higher quality. Better design. Lasts longer.

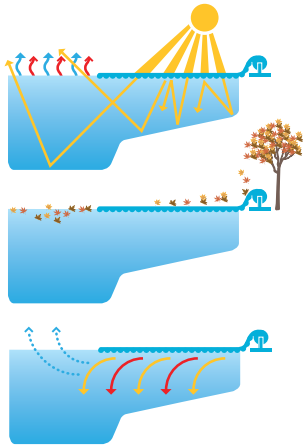

Daisy Saves
warmth and evaporation

Daisy Saves
on cleaning

Daisy Saves
on chemical loss

REDUCE THE COST OF MAINTAINING A WARM SUSTAINABLE POOL.

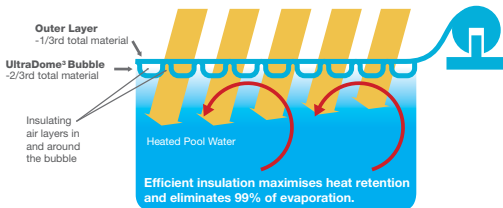

THE DAISY DIFFERENCE

The bubble is the same thickness throughout for greater strength and longer life

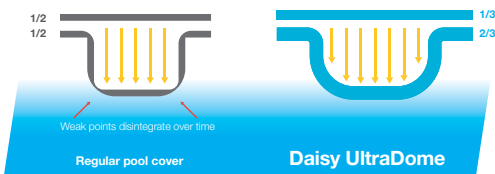

WinterKleen covers are ideal when the pool is not in use for extended periods and save your UltraDome Daisy cover from unnecessary exposure. WinterKleen stretches tightly over your pool so that leaves and debris blow off.

1 CHOOSE YOUR COVER

We stand by our product

We honour all warranty claims promptly. If you have a problem with any Daisy product call us and we'll fix it.

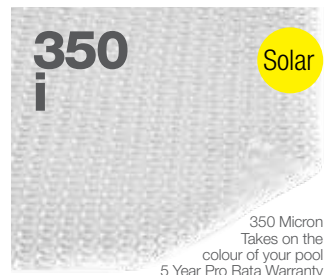
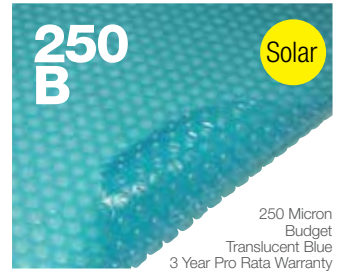
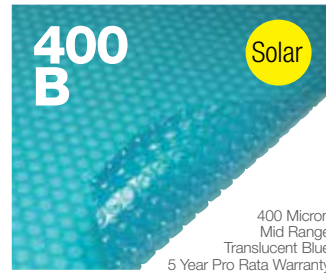
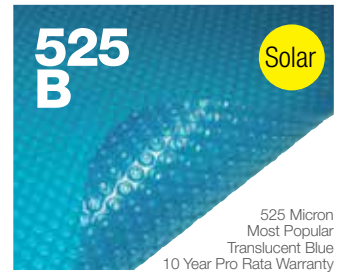
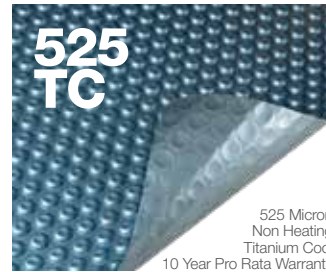
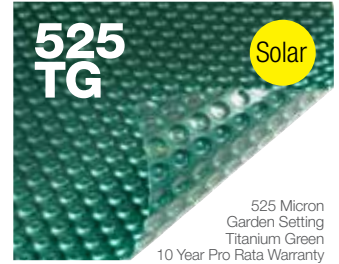

2 CHOOSE YOUR ROLLER

Each roller is made for a small, medium or large pool. An overcover and cover attachment kit is supplied with every domestic roller.

5 Star Roller Range 10 year pro rata warranty



A75 Stationary for smaller pools
SQ Squat profile



ST Stationary
MK II Directional mobile



LP Fully mobile, low profile
FM Fully mobile



AGA Above ground, adjustable
316ST Marine grade, SAE 316 Stainless Steel



DP Daisy Power Electric roller, battery powered AC charge + solar models
UBR Under Bench Roller
125FM Fully mobile for longer wider pools



BGB Below Ground Box
DMR Deck Mount Roller
125ST Stationary for longer wider pools



MAXI Semi Commercial Fully Mobile for larger pools
UTC Roller Range - 5 year pro rata warranty
BUDDY Cost effective for small pools
UTC 75/100 Cost effective 75 or 100mm for small to large pools
UTCAG Cost effective 50 or 75mm for above ground pools



3 POOL SIZE

Simply decide on the essential details:

- (1) type of cover
- (2) roller system
- (3) pool size: length (B) X width (A) (+ step area) = Total square metres.

Ask for a quote let's say - 52m² 525B with an ST roller. Take into account if your pool is indoors or outside. Do you need more heat or less or have leaf debris. Remember your roller adds years to the life of the cover. Does your pool have non-standard features? These are some determining facts you need to discuss with us.

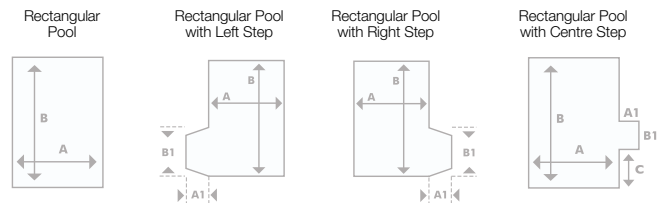
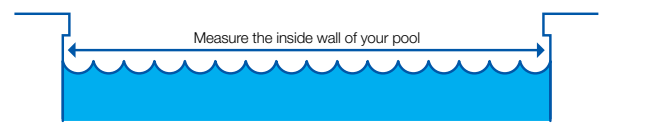

For shaped pools, treat as rectangular

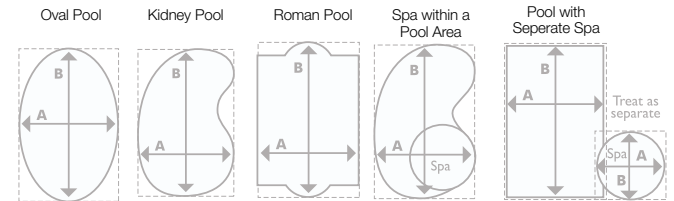

And the answer is:

My Daisy Cover: \$

My Daisy Roller: \$

Square Metre Total:

Installation: \$

Distributor Quote from:

4 ORDER YOUR DAISY FROM AN APPROVED EXPERT

DAISY POOL COVER / ROLLER ORDER

Your Order Number

BILLING DETAILS

Date: _____
 Business name: _____
 Street Address: _____
 Suburb: _____ Postcode: _____
 State: _____ Phone: _____

PAYMENT

Card Number: _____
 Expiry date: _____
 Do not write customers payment details

POOL MEASUREMENTS

Pool Length: _____ x
 Pool Width: _____
 or Pool Name: _____
 Precut Yes
 Step Area LH RH
 Step Length _____
 Step Width _____

COVERS

	Tick <input type="checkbox"/>	Size
525TB	<input type="checkbox"/>	
525TG	<input type="checkbox"/>	
525B	<input type="checkbox"/>	
525TC	<input type="checkbox"/>	
400B	<input type="checkbox"/>	
350i	<input type="checkbox"/>	
250B	<input type="checkbox"/>	
TTB Foam	<input type="checkbox"/>	
TTG Foam	<input type="checkbox"/>	
TTS Foam	<input type="checkbox"/>	
092 Refit kit for existing rollers	<input type="checkbox"/>	
Overcover for existing rollers	<input type="checkbox"/>	
WK Mesh Black WinterKleen	<input type="checkbox"/>	
WK Mesh Blue WinterKleen	<input type="checkbox"/>	
WK Mesh Green WinterKleen	<input type="checkbox"/>	
WK Mesh Grey WinterKleen	<input type="checkbox"/>	
WK Mesh Tan WinterKleen	<input type="checkbox"/>	
WinterKleen Curvilinear Measure	<input type="checkbox"/>	photocopy page 25
Accessories N ^o	<input type="checkbox"/>	

SHIPPING DETAILS

Only fill in this section to drop ship to your customer

Customer name: _____
 Street Address: _____
 Suburb: _____ Postcode: _____
 State: _____ Phone: _____
 Extra Info _____

ROLLERS

	Black	Grey	White	Tick <input type="checkbox"/>	Size
A75	<input type="checkbox"/>	<input type="checkbox"/>	<input type="checkbox"/>		
SQ				<input type="checkbox"/>	
ST	<input type="checkbox"/>	<input type="checkbox"/>	<input type="checkbox"/>		
MKII	<input type="checkbox"/>	<input type="checkbox"/>	<input type="checkbox"/>		
LP				<input type="checkbox"/>	
FM				<input type="checkbox"/>	
316ST				<input type="checkbox"/>	
AGA				<input type="checkbox"/>	
125ST				<input type="checkbox"/>	
125FM				<input type="checkbox"/>	
125Maxi				<input type="checkbox"/>	
Daisy Power SQ				<input type="checkbox"/>	
Daisy Power ST				<input type="checkbox"/>	
Solar Panel PV				<input type="checkbox"/>	
Buddy 50/75				<input type="checkbox"/>	
UTC AG 50/75				<input type="checkbox"/>	
UTC 75/100				<input type="checkbox"/>	
UBR CA	<input type="checkbox"/>	CS <input type="checkbox"/>	LO <input type="checkbox"/>	WRC <input type="checkbox"/>	POWER <input type="checkbox"/>
Other Styles/Products				DMR <input type="checkbox"/>	
				BGB <input type="checkbox"/>	
				BGBSMALL <input type="checkbox"/>	
Daisy Drill Drive				<input type="checkbox"/>	
Daisy Install				<input type="checkbox"/>	Yes

Only in Perth and Sydney Metro



AUSTRALIA'S LARGEST SUPPLIER OF POOL COVERS AND ROLLERS

Administration Centre: 8 Granite Place, Welshpool, WA 6106. NSW Production Centre: 120 Newton Road Wetherill Park NSW 2164
 1300 551 811 Int: +618 9251 7999 Fax: 1300 885 242 Email: sales@daisypoolcovers.com.au daisypoolcovers.com.au